

**INSURANCE IS ONE PRODUCT YOU BUY  
HOPING YOU'LL NEVER HAVE TO USE IT**

*Nobody likes to think about a wrecked car, or a burned-out home or business. So nobody likes to think about insurance.*

*But if those things are difficult to think about before they happen, imagine how difficult they are to deal with when they happen.*

*That's why one of the most critical decisions you'll make in buying insurance is choosing the company to buy it from.*

*At INA we've had enough experience over the past 180 years to realize that it often takes more than paying a claim to help people overcome the tragedies that strike.*

*At the very least it requires an understanding that the loss is often more than monetary. At the most, it can mean helping people build an entirely new life out of what remains.*

*That's something we've done on countless occasions. Because at INA we've found that while that may mean more work for us, it also means more business.*



Where an insurance policy is more than just a piece of paper.

Insurance Company of North America  
Life Insurance Company of North America  
Pacific Employers Group  
World Headquarters, Philadelphia

*DisneylandGuideMaps.com*

Fall/Winter 1973-74

# Disneyland GUIDE

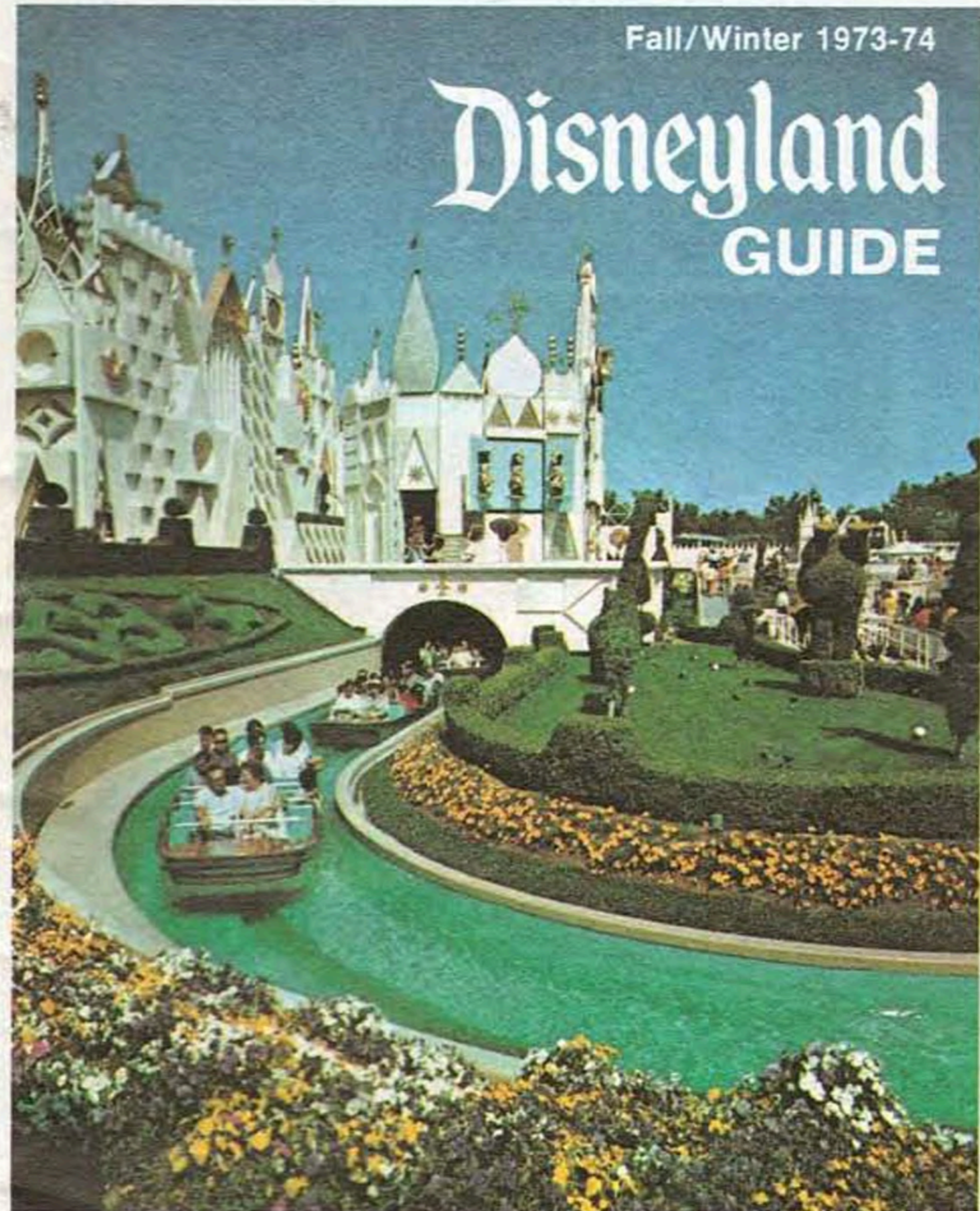

© 1973 Walt Disney Productions

PRESENTED BY



**"THE HAPPIEST PLACE ON EARTH."** That's the way millions of people feel about Disneyland. And that's the way those of us who work here want you to feel about it, too. Your Disneyland Guide, provided by Insurance Company of North America, will help make your day a memorable one.

# INA

*The Insurance Company of North America is happy to provide you with this guide to help you get the maximum enjoyment from your Disneyland visit.*



**Christmas Holidays** — December 15 - January 1 — **Fantasy on Parade** — The highlight of Disneyland's fall/winter season is this spectacular parade, which features a host of famous Disney characters in a gala cavalcade of colors and sounds. The parade is daily. The premiere parade on December 15, is held at 9 p.m.

**Candlelight Procession** — December 15 and 16. A traditional ceremony to start the holiday season, the Candlelight Procession features a thousand carolers moving down Main Street, U.S.A. to Town Square where the Christmas Story is narrated and sung. This inspiring performance is two nights only at 6 p.m.

**New Year's Eve Party** — December 31 — From 8:30 p.m. to 2:30 a.m., Disneyland guests can ring out the old year and bring in the new during this exciting New Year's Eve Party, which features a full evening of listening and dancing to top name entertainers and a spectacular fireworks display at midnight. (Special tickets for this event, which also include unlimited use of all Disneyland attractions except shooting galleries, must be purchased in advance.)

## Table of Contents

	Page
General Information .....	2-3
The A-B-C's of Ticket Books .....	4
Guided Tour Information .....	4
Disneyland Adventures and Attractions .....	5-7
Main Street, U.S.A. ....	8-9
Adventureland .....	10-11
New Orleans Square .....	12-13
Bear Country .....	14-15
Map of Disneyland .....	16-17
Frontierland .....	18-19
Fantasyland .....	20-21
Tomorrowland .....	22-23
Food and Refreshments .....	24-25
Shops and Stores .....	26-29
Your Entertainment Calendar .....	30-33
Free Shows and Exhibits .....	33

## General Information

General information about Disneyland may be obtained at City Hall, in Town Square. As you explore "the happiest place on earth," feel free to ask any employee for assistance.

Information about other Southern California recreational attractions and public transportation schedules may be obtained at the information center located at the corner of Main and East Plaza Streets.

### BABY STATION

The Baby Station is located adjacent to the First Aid Center on East Plaza Street. Facilities are provided for preparing formulas, warming bottles, breast feeding, and changing infants. Sorry, babysitting is not available.

### BANKAMERICARD

Your BankAmericard is accepted in most shops, stores and restaurants.

### BANKING SERVICES

The Bank of America, located on Town Square provides complete banking facilities. Banking hours are 10 a.m. to 4 p.m. every day Disneyland is open (on Wednesdays, the Bank is open from 10 a.m. to 6 p.m.).

Check cashing for the amount of purchase, or up to \$10 in cash with proper identification, is available after the Bank closes at the Main Street Railroad Station ticket booth, located on Town Square.

### CAMERA AND FILM SERVICE

Camera rental, service, and film processing are available in the Disneyland Camera Shop, in the GAF Photo Salon on Main Street. Film may be purchased at shops and merchandise stands throughout the Park. Photo-Trail signs are provided in every land to assist you in your picture-taking.

### FIRST AID

Registered nurses are on duty at all times in the First Aid Center, at the end of East Plaza Street, just off Main Street.

### GULF SERVICE STATION

Guests visiting Disneyland can have their cars serviced at the Gulf Service Station located at the corner of Katella Avenue and West Street.

### LOCKER SERVICE

Facilities for checking purchases and garments are located in the Global Van Lines Building in Town Square. Lockers large enough for suitcases are located near the tram station, west of the Main Entrance.

### LOST AND FOUND

Lost and found facilities are maintained in the Global Van Lines Building, between the Fire Station and Emporium on Town Square, Main Street.

### LOST CHILDREN

Facilities for the care of lost children are maintained at the end of East Plaza Street, off Main Street. The hostess on duty will assist you.

### PARK OPERATING HOURS: Effective 9-9-73 to 2-24-74.

During the fall/winter season, beginning September 16, Disneyland is open from 10 a.m. to 6 p.m., Wednesdays through Fridays, and from 9 a.m. to 7 p.m. Saturdays and Sundays. The Park is closed Mondays and Tuesdays. (During the Christmas holidays, December 15 through January 1, Disneyland will be open every day.)

In addition to the Christmas holidays, other special entertainment events may affect Disneyland's hours and days of operation. A list of these events will be found in the "Entertainment" section of this brochure. (Park operating hours subject to change.)

### PET CARE

You may leave your pet in an airy, individual enclosure at a cost of only 50¢ for the entire day. This charge includes a choice of Kal Kan pet food. This facility, sponsored by Kal Kan, is located to the right of the Main Gate Ticket Booths. Sorry, pets cannot be left overnight.

### POSTAGE STAMPS AND MAIL SERVICE

Stamps are available in vending machines located in each land and at the Hallmark Communication Center on Main Street. Mail boxes for your letters and cards are located throughout Disneyland.

### PUBLIC TELEPHONES ☎

Public telephones are located throughout Disneyland. Ask any Disneylander for directions or see the area maps.

### REST ROOMS △

Rest rooms are located throughout Disneyland. Refer to the area maps in this guide, or ask any Disneyland employee.

### SECURITY

In most areas of the Park, Disneyland Security can be recognized by the theme area dress. If you need assistance, ask any Disneylander.

### STROLLERS AND WHEELCHAIRS

Strollers and wheelchairs are available for a nominal fee, to the right just inside the Main Gate turnstiles.

### WHEN LEAVING DISNEYLAND

If you wish to return to Disneyland today, have your hand stamped at the Exit Gate or at the Disneyland Hotel Monorail Station before leaving.

## The A-B-C's etc. of Disneyland Ticket Books

Disneyland Ticket Books are a most convenient way to enjoy "the happiest place on earth." Both the Big 11 and the Deluxe 15 Ticket Books include admission to Disneyland and a selection of adventures and attractions on an "A," "B," "C," "D," and "E" ticket basis.

**THE BIG 11** Ticket Book includes Admission to the Park and a selection of attractions as shown below:

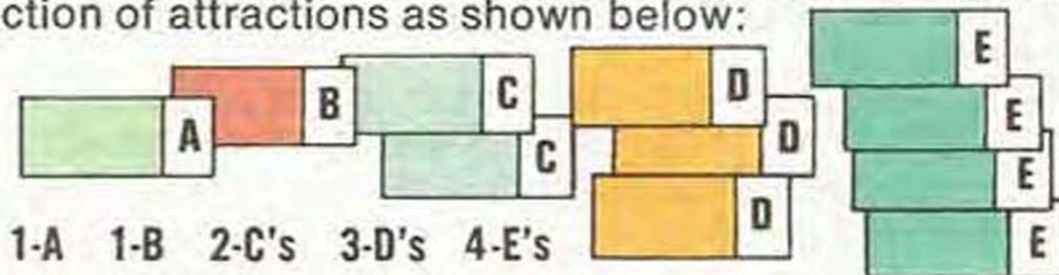

**THE DELUXE 15** Ticket Book includes Admission to the Park and a selection of attractions as shown below:

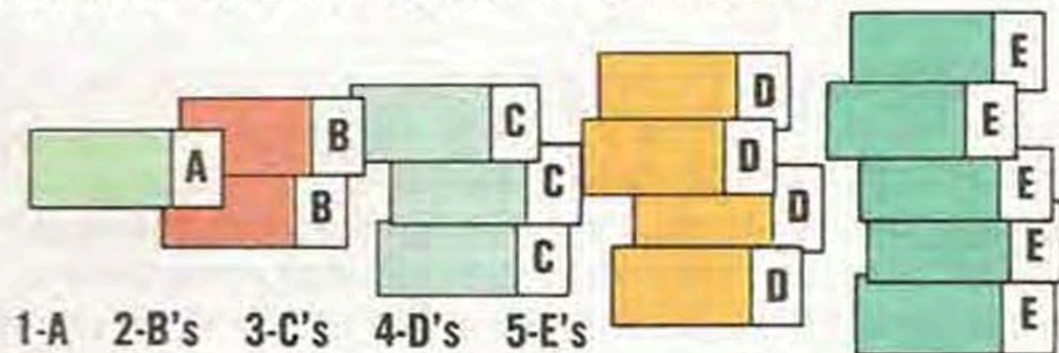

If you have already purchased a general admission ticket, or if you wish to enjoy additional adventures inside the Park, you may buy a 10-adventure book (1A, 1B, 2C, 3D, 3E) or a 5-adventure book (5E's) for \$3.50 at any central ticket booth inside the Park. Either book may be used by anyone regardless of age.

Prices subject to change without notice.

## Guided Tour Information

The popular Guided Tour is especially recommended for "first time guests." Visitors are taken on an exciting tour of Disneyland by a charming Guide who tells the fascinating story of the history and growth of "the happiest place on earth." The Guided Tour includes admission to Disneyland and a selection of seven of the Park's popular attractions.

If you already have purchased a General Admission ticket, you may buy a Guided Tour Ticket at the Main Street Railroad Station ticket booth, located in Town Square. Tour tickets, minus Main Gate admission, are \$3.00 for adults, juniors and children.

## Adventures and Attractions

### **A** coupon or 10c

#### **HORSE DRAWN STREET CARS (Main Street)**

Board a horse-drawn trolley, as it travels down a main street of 70 years ago.



#### **OMNIBUS (Main Street)**

Ride a double-decker bus down Main Street, to the hub of Disneyland.

**HORSELESS CARRIAGE (Main Street)**  
A trip down Main Street aboard a replica of America's classic autos.



#### **FIRE ENGINE (Main Street)**

"Answer the alarm" in Disneyland's very own fire wagon.



#### **KING ARTHUR CARROUSEL (Fantasyland)**

Ride to the land of fantasy on one of the Carrousel's 72 prancing steeds.



#### **SLEEPING BEAUTY CASTLE (Fantasyland)**

See diorama scenes from the popular Walt Disney movie, "Sleeping Beauty."



### **B** coupon or 25c

#### **MAIN STREET CINEMA (Main Street)**

Enjoy the greats of the silent screen era.



#### **MOTOR BOAT CRUISE (Fantasyland)**

Guide your motorboat through treacherous rapids and tricky currents.

#### **SWISS FAMILY TREEHOUSE (Adventureland)**

See the Swiss Family Robinson's tree-top home and enjoy an aerial view of Disneyland.



#### **CASEY JR. CIRCUS TRAIN (Fantasyland)**

The bright, gay circus train who "knew he could," travels a scenic route.

#### **ALICE IN WONDERLAND (Fantasyland)**

Re-live the fantastic adventures of Alice.



### **C** coupon or 40c

#### **FANTASYLAND THEATER**

Enjoy a Disney movie.



#### **MAD TEA PARTY (Fantasyland)**

Whirl and twirl in the Mad Hatter's wildly spinning cups and saucers.



**SHOOTING GALLERIES** (Frontierland, Adventureland) Test your sharpshooting skills at still and moving targets.



**DUMBO FLYING ELEPHANTS** (Fantasyland) Soar high over Fantasyland aboard the elephant with aerodynamic ears.



**SNOW WHITE'S ADVENTURES** (Fantasyland) Travel through the Dark Forest to the Seven Dwarf's Diamond Mine. (Scary)



**ADVENTURE THRU INNER SPACE** presented by **MONSANTO** (Tomorrowland) A thrilling journey into the world of the atom.

**AUTOPIAS** (Fantasyland, Tomorrowland) Youngsters can navigate these freeways of the future.



**PETER PAN FLIGHT** (Fantasyland) Fly over moonlit London and on to Never-Never Land aboard a pirate galleon.



**MR. TOAD'S WILD RIDE** (Fantasyland) A hilarious ride through old London.

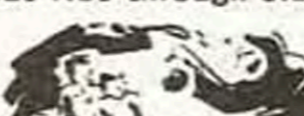

**MIKE FINK KEEL BOATS** (Frontierland) A backwoods water journey to adventure, on the Rivers of America.

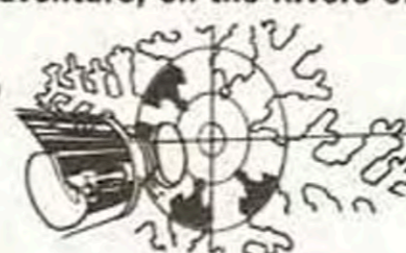

**coupon or 70c**



**PEOPLEMOVER** presented by **GOODYEAR** (Tomorrowland) Travel throughout Tomorrowland and get an "inside" glimpse of each attraction.

**ROCKET JETS** (Tomorrowland) Pilot a high-flying jet to Disneyland's outer space.



**STORYBOOK LAND CANAL BOATS** (Fantasyland) View the World of Fairy Tales.



**FLIGHT TO THE MOON** presented by **McDONNELL DOUGLAS** (Tomorrowland) Take a journey to the Moon and visit Mission Control.



**TOM SAWYER ISLAND RAFTS** (Frontierland) Explore Tom Sawyer island, with its many caves and Fort Wilderness. (closed at dusk)



**SKYWAY** (Tomorrowland, Fantasyland) A one-way view of Tomorrowland and Fantasyland from skyway buckets.



**DAVY CROCKETT'S EXPLORER CANOES** (Bear Country) Row your own explorer canoe on the Rivers of America.



**SANTA FE & DISNEYLAND RAILROAD** (Main Street, New Orleans Square and Tomorrowland) All aboard for a circular tour of Disneyland.

**COLUMBIA SAILING SHIP** (Frontierland) Cruise on a replica of the first American ship to circle the globe.



**MARK TWAIN STEAMBOAT** (Frontierland) Ride the gleaming sternwheeler as it travels around the Rivers of America.



**coupon or 85c (adults)**  
**(children 75c)**

**MINE TRAIN RIDE** (Frontierland) A Western-style adventure through Nature's Wonderland, Rainbow Caverns.

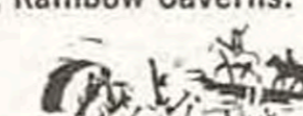

**PACK MULES** (Frontierland) See Nature's Wonderland from the back of a sturdy pack mule.

**JUNGLE RIVER CRUISE** (Adventureland) Travel through tropical jungles and exotic areas of the world on a jungle boat.



**DISNEYLAND-ALWEG MONORAIL TRAINS** (Tomorrowland) Circle above and around Disneyland on the transportation system of tomorrow.

**MATTERHORN BOBSLEDS** (Fantasyland) Race down and around "snow covered" slopes in a fast-moving bobsled.



**ENCHANTED TIKI ROOM** (Adventureland) A Polynesian Paradise, where 225 birds, flowers and tropical tikis entertain.



**IT'S A SMALL WORLD** presented by **BANK OF AMERICA** (Fantasyland) Join the happiest crew that ever sailed around the world.



**PIRATES OF THE CARIBBEAN** (New Orleans Square) Sail through the wildest adventure that ever rocked the Spanish Main.



**SUBMARINE VOYAGE** (Tomorrowland) Journey through "liquid space" on an exciting undersea cruise to the North Pole.



**COUNTRY BEAR JAMBOREE** (Bear Country) The wildest show in the wilderness, featuring Big Al, Teddi Barra and a cast of 18 "Bears in the Band".



**HAUNTED MANSION** (New Orleans Square) Join the 999 "frightfully funny" ghosts.



# MAIN STREET, U.S.A.

Letters in quotes by each adventure and attraction show ticket used.

FANTASYLAND  
FRONTIERLAND  
ADVENTURELAND  
TOMORROWLAND

PLAZA

W. PLAZA

E. PLAZA

W. CENTER

E. CENTER

TOWN SQUARE

MAIN ENTRANCE

PLAZA INN

PLAZA PAVILION

PLAZA GARDENS

PLAZA

PLAZA

PLAZA

PLAZA

PLAZA

PLAZA

PLAZA

PLAZA

PLAZA

PLAZA

PLAZA

PLAZA

PLAZA

PLAZA

PLAZA

PLAZA

PLAZA

PLAZA

PLAZA

PLAZA

PLAZA

PLAZA

PLAZA

PLAZA

PLAZA

PLAZA

PLAZA

PLAZA

## INFORMATION AND ASSISTANCE

- ① Guided Tour Garden
- ② Disneyland City Hall
- ③ Information Center

## ADVENTURES AND ATTRACTIONS

- ✓ ④ Santa Fe & Disneyland Railroad "D"
- ⑤ Omnibus "A"
- ⑥ Horseless Carriage "A"
- ⑦ Horse Drawn Street Cars "A"
- ⑧ Fire Engine "A"
- ⑨ Main Street Cinema "B"
- ⑩ Penny Arcade

## SERVICES

- ⑪ Strollers and Wheel Chairs
- ⑫ Bank of America
- ⑬ Global's Storage Lockers and Lost and Found Articles
- ⑭ Baby Station
- ⑮ First Aid and Lost Children

## FOOD AND REFRESHMENTS

- ⑯ Hills Bros. Coffee House and Garden
- ⑰ Carnation Ice Cream Parlor
- ⑱ Sunkist Citrus House
- ⑲ Coca Cola Refreshment Corner
- ⑳ Plaza Pavilion
- ㉑ Plaza Inn
- ㉒ Carnation Plaza Gardens

## FREE SHOWS AND EXHIBITS

- ㉓ The Walt Disney Story presented by Gulf
- ㉔ Market House
- ㉕ GAF Photo Salon

## SHOPS AND STORES

- ㉖ Souvenir Stands
- ㉗ Mad Hatter Shop
- ㉘ Emporium
- ㉙ Magic Shop
- ㉚ Tobacco Shop
- ㉛ "Rings 'n Things"
- ㉜ Glassblower
- ㉝ Hurricane Lamp Shop
- ㉞ Story Book Shop
- ㉟ Candle Shop
- ㊱ Elgin New Century Clock Shop
- ㊲ Flower Market
- ㊳ Art Festival
- ㊴ Hallmark Communication Center
- ㊵ Camera Shop
- ㊶ Crystal Arts
- ㊷ Silhouette Studio
- ㊸ China Shop
- ㊹ Candy Palace

## TELEPHONES

## REST ROOMS

## TICKET BOOTHS

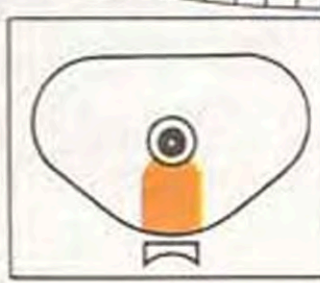

# Adventureland

Letters in quotes by each adventure and attraction show ticket used.

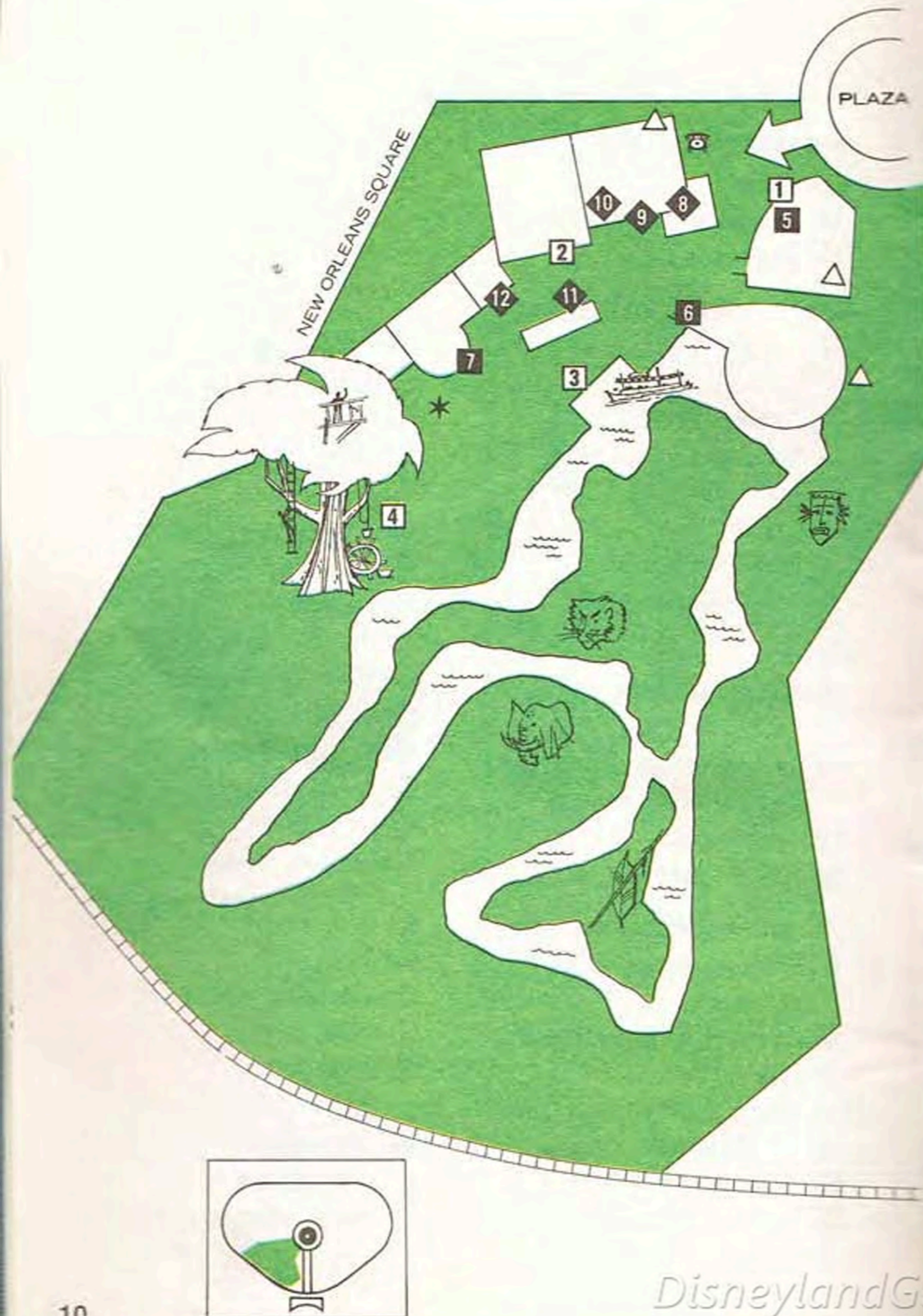

## ADVENTURES AND ATTRACTIONS

- 1 Enchanted Tiki Room "E"
- 2 Big Game Shooting Gallery "C"
- 3 Jungle River Cruise "E"
- 4 Swiss Family Treehouse "B"

## FOOD AND REFRESHMENTS

- 5 Tiki Juice Bar
- 6 Tahitian Terrace
- 7 Sunkist "I Presume"

## SHOPS AND STORES

- 8 Far East Imports
- 9 Magic Carpet
- 10 Adventureland Traders
- 11 Tropical Imports
- 12 Guatemalan Weavers

## TELEPHONES

## REST ROOMS

## TICKET BOOTHS

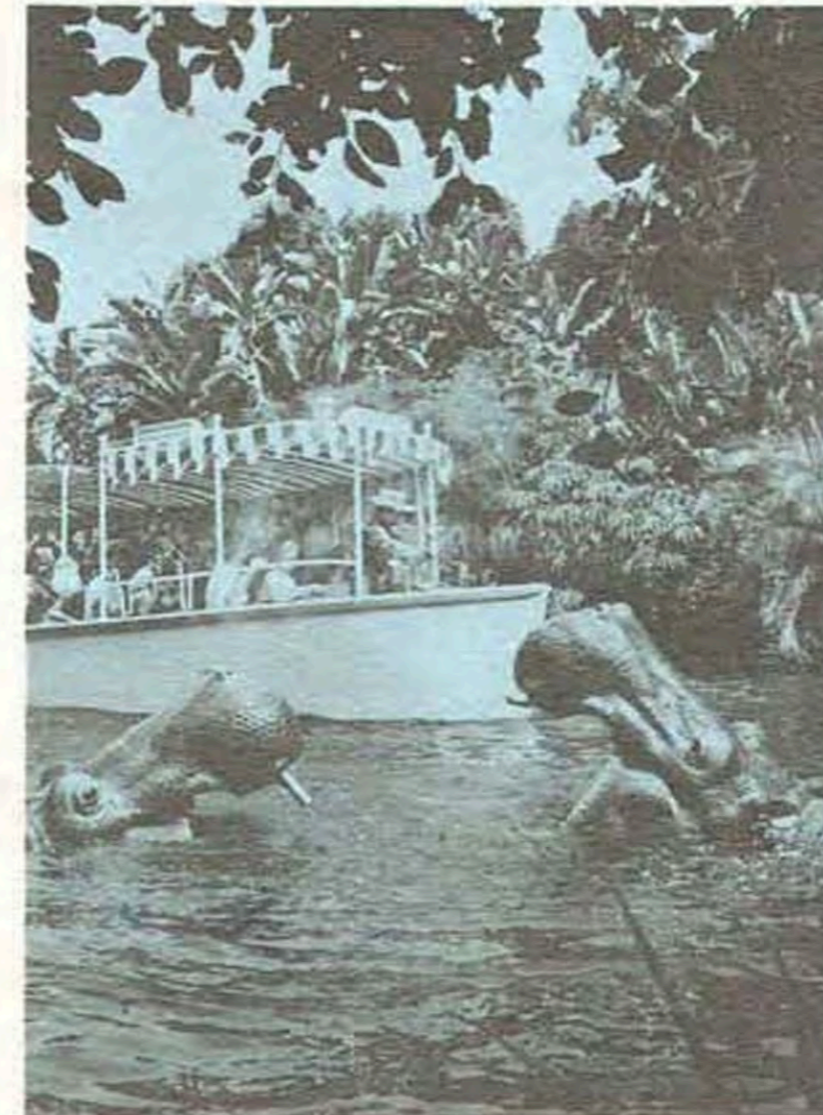

# New Orleans Square

Letters in quotes by each adventure and attraction show ticket used.

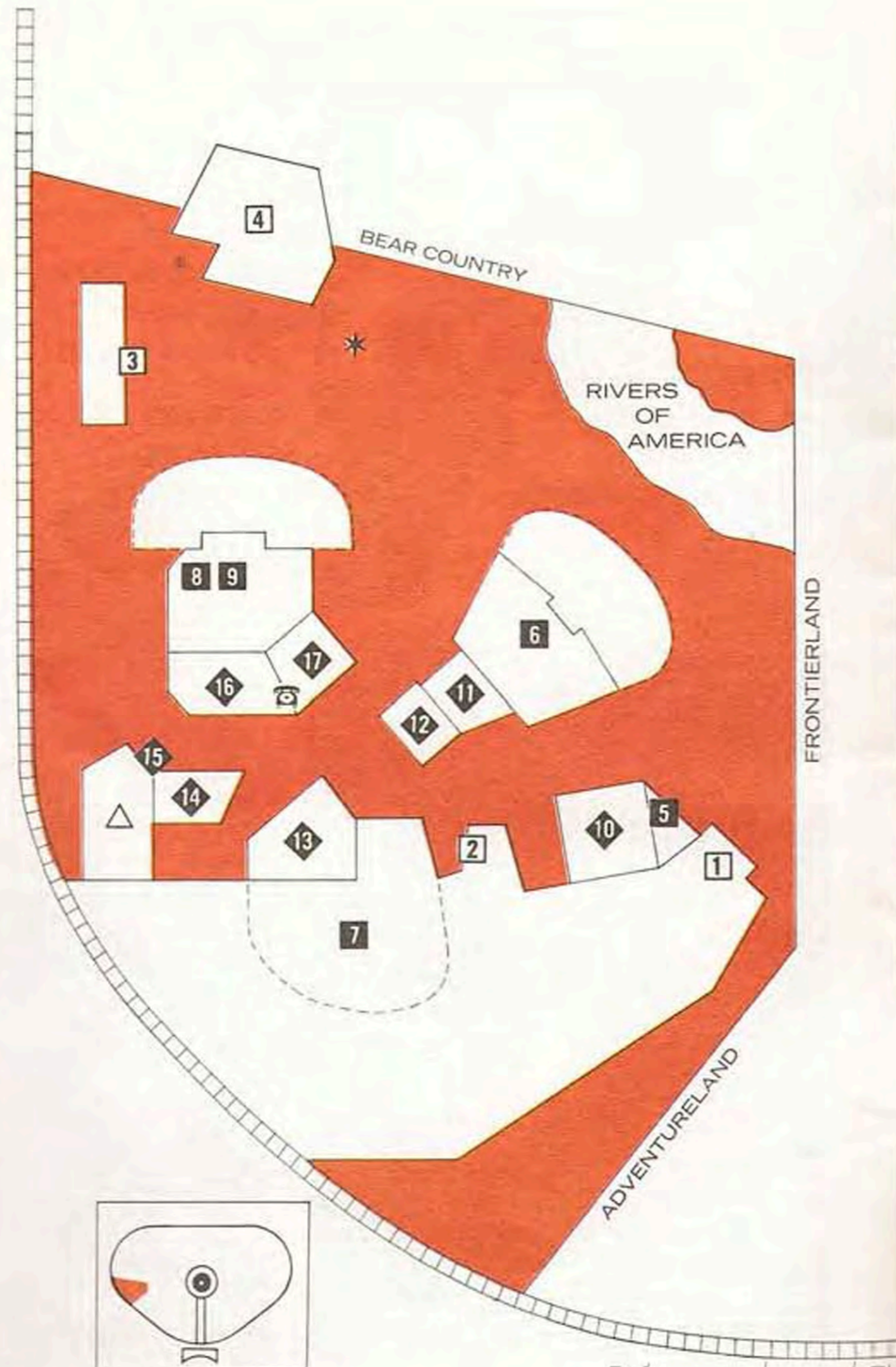

## ADVENTURES AND ATTRACTIONS

- 1 Pirates of the Caribbean "E"
- 2 Pirates Arcade Museum
- 3 Santa Fe & Disneyland Railroad "D"
- 4 Haunted Mansion "E"

## FOOD AND REFRESHMENTS

- 5 Royal Street Veranda
- 6 Sara Lee Café Orleans
- 7 The Blue Bayou Restaurant
- 8 The Mint Julep Bar
- 9 The French Market

## SHOPS AND STORES

- 10 One-Of-A-Kind
- 11 Laffite's Silver Shop
- 12 Cristal d' Orleans
- 13 Le Gourmet
- 14 Le Forgeron
- 15 Portrait Artist
- 16 Marché Aux Fleurs, Sacs Et Modes
- 17 Mlle. Antoinette's Parfumerie

## TELEPHONES

## REST ROOMS

## TICKET BOOTHS





# BEAR COUNTRY

Letters in quotes by each adventure and attraction show ticket used.

## ADVENTURES AND ATTRACTIONS

- 1 Davy Crockett's Explorer Canoes "D"
- 2 Country Bear Jamboree "E"
- 3 Teddi Barra Swingin Arcade

## SHOPS AND STORES

- 6 Indian Trading Post
- 7 Wilderness Outpost

☎ TELEPHONES

△ RESTROOMS

\* TICKET BOOTHS

## FOOD AND REFRESHMENTS

- 4 Hungry Bear Restaurant
- 5 Mile Long Bar

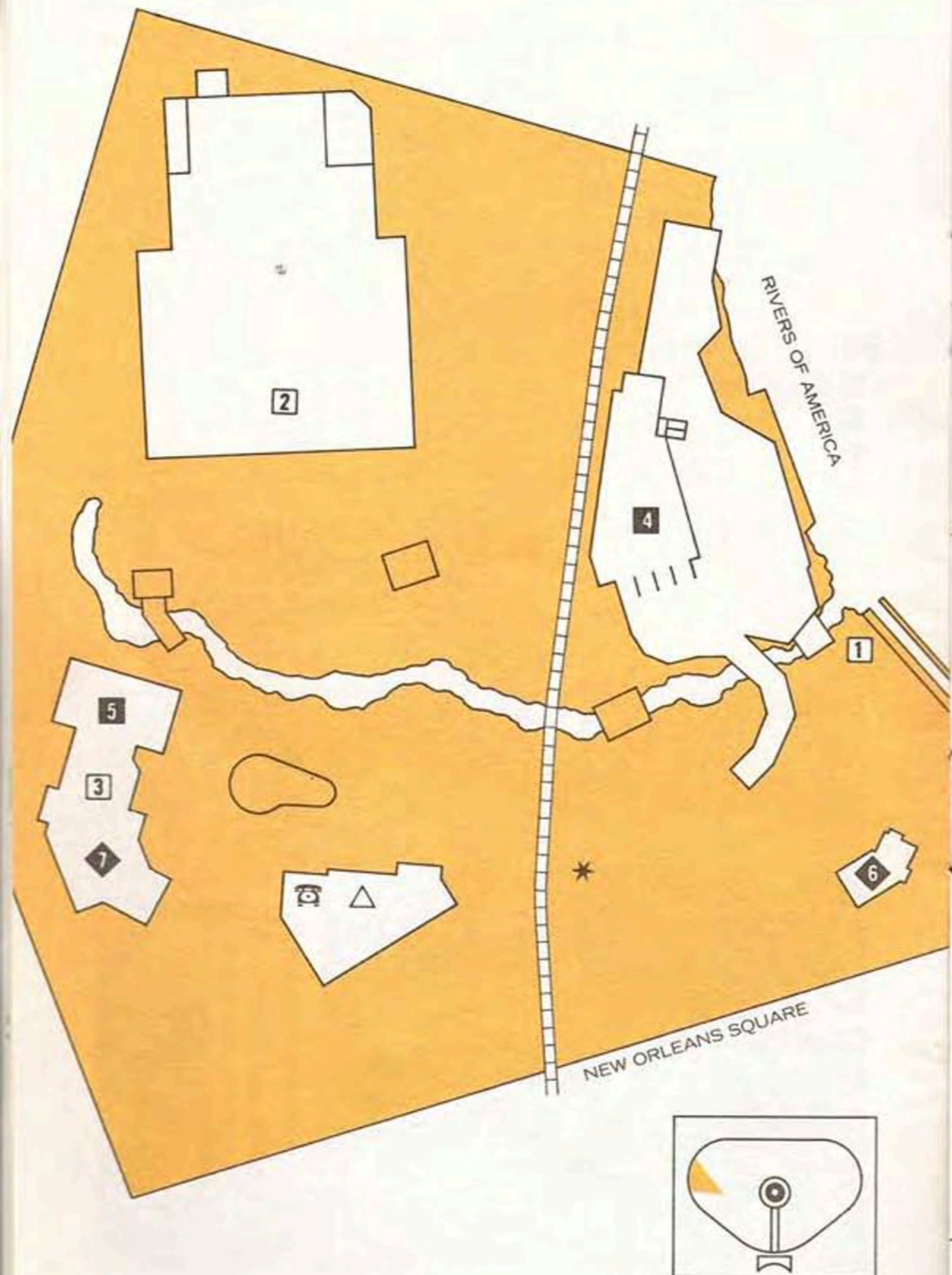

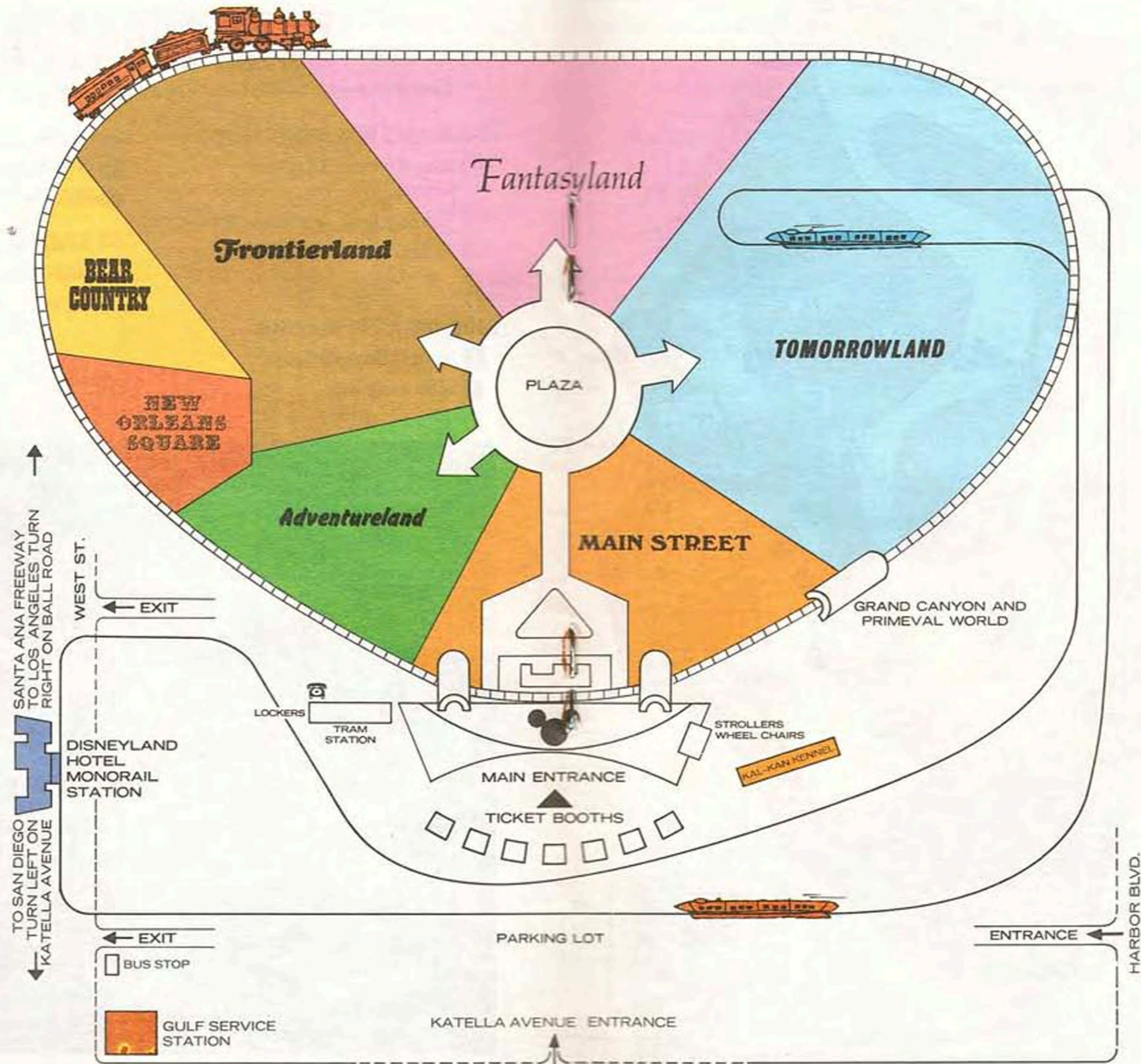

# Frontierland

Letters in quotes by each adventure and attraction show ticket used.

## ADVENTURES AND ATTRACTIONS

- 1 Shooting Gallery "C"
- 2 Mine Train Ride "E"
- 3 Pack Mules "E"
- 4 Columbia Sailing Ship "D"
- 5 Mark Twain Steamboat "D"
- 6 Tom Sawyer Island Rafts "D"
- 7 Mike Fink Keel Boats "C"

## FOOD AND REFRESHMENTS

- 8 Casa de Fritos
- 9 Burrito Wagon (Weekends Only)
- 10 Pepsi-Cola Golden Horseshoe
- 11 Oaks Tavern
- 12 Wheelhouse
- 13 Oscar Mayer River Belle Terrace
- 14 Fort Wilderness Snack Bar

## SHOPS AND STORES

- 15 Frontier Trading Post
- 16 Davy Crockett Arcade  
Frontierland Hats  
Frontier Print Shop  
Frontier Rock Shop  
Mexican Imports  
Souvenir Stand
- 17 Pendleton Woolen  
Mills Store
- 18 Frontierland Camera Shop

## FREE SHOWS AND EXHIBITS

- 19 Frontierland Arcade  
Gun Collection
- 20 Pepsi-Cola Golden  
Horseshoe Revue

- ☎ TELEPHONES
- △ REST ROOMS
- \* TICKET BOOTHS

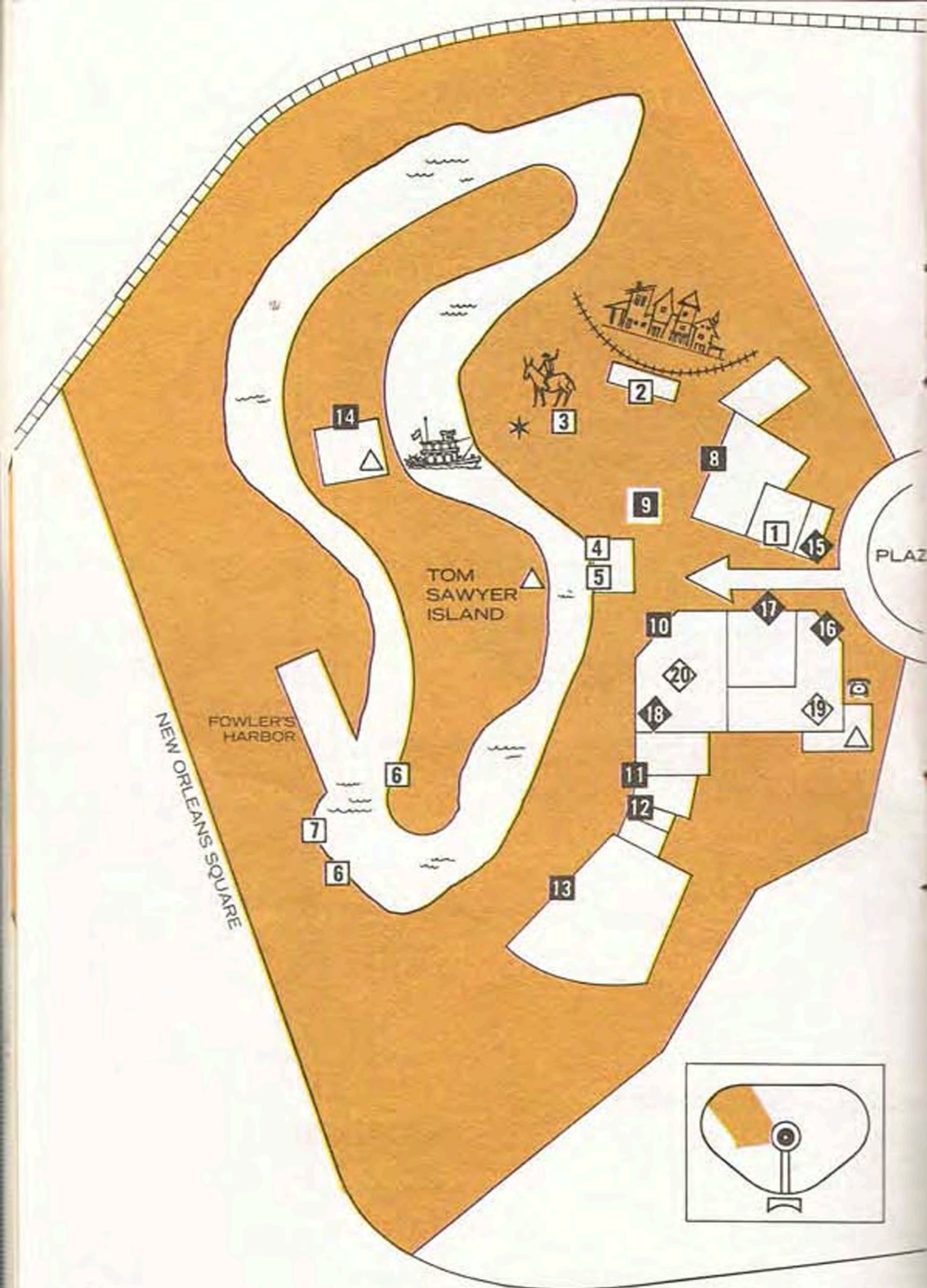

# FANTASYLAND

Letters in quotes by each adventure and attraction show ticket used.

## ADVENTURES AND ATTRACTIONS

- 1 Sleeping Beauty Castle "A"
- 2 Peter Pan Flight "C"
- 3 King Arthur Carrousel "A"
- 4 Snow White's Adventures (Scary) "C"
- 5 Fantasyland Theatre "C"
- 6 Mad Tea Party "C"
- 7 Mr. Toad's Wild Ride "C"
- 8 Dumbo Flying Elephants "C"
- 9 Skyway to Tomorrowland "D"
- 10 Casey Jr. Circus Train "B"
- 11 Storybook Land Canal Boats "D"
- 12 Alice in Wonderland "B"
- 13 Matterhorn Bobsleds "E"
- 14 Fantasyland Autopia "C"
- 15 Motor Boat Cruise "B"
- 16 "It's A Small World" "E"  
presented by Bank of America

## FOOD AND REFRESHMENTS

- 17 Welch's Grape Juice Bar
- 18 Character Food Stands
- 19 Captain Hook's Pirate Ship

## SHOPS AND STORES

- 20 Castle Candy Shop
- 21 Arts and Crafts
- 22 Glassblower
- 23 Tinkerbell Toy Store
- 24 Merlin's Magic Shop
- 25 Mad Hatter
- 26 Souvenir Stands
- 27 Fantasy Gift Fair
- 28 Caricatures
- 29 Small World Stand

☎ TELEPHONES

△ REST ROOMS

\* TICKET BOOTHS



# TOMORROWLAND

Letters in quotes by each adventure and attraction show ticket used.

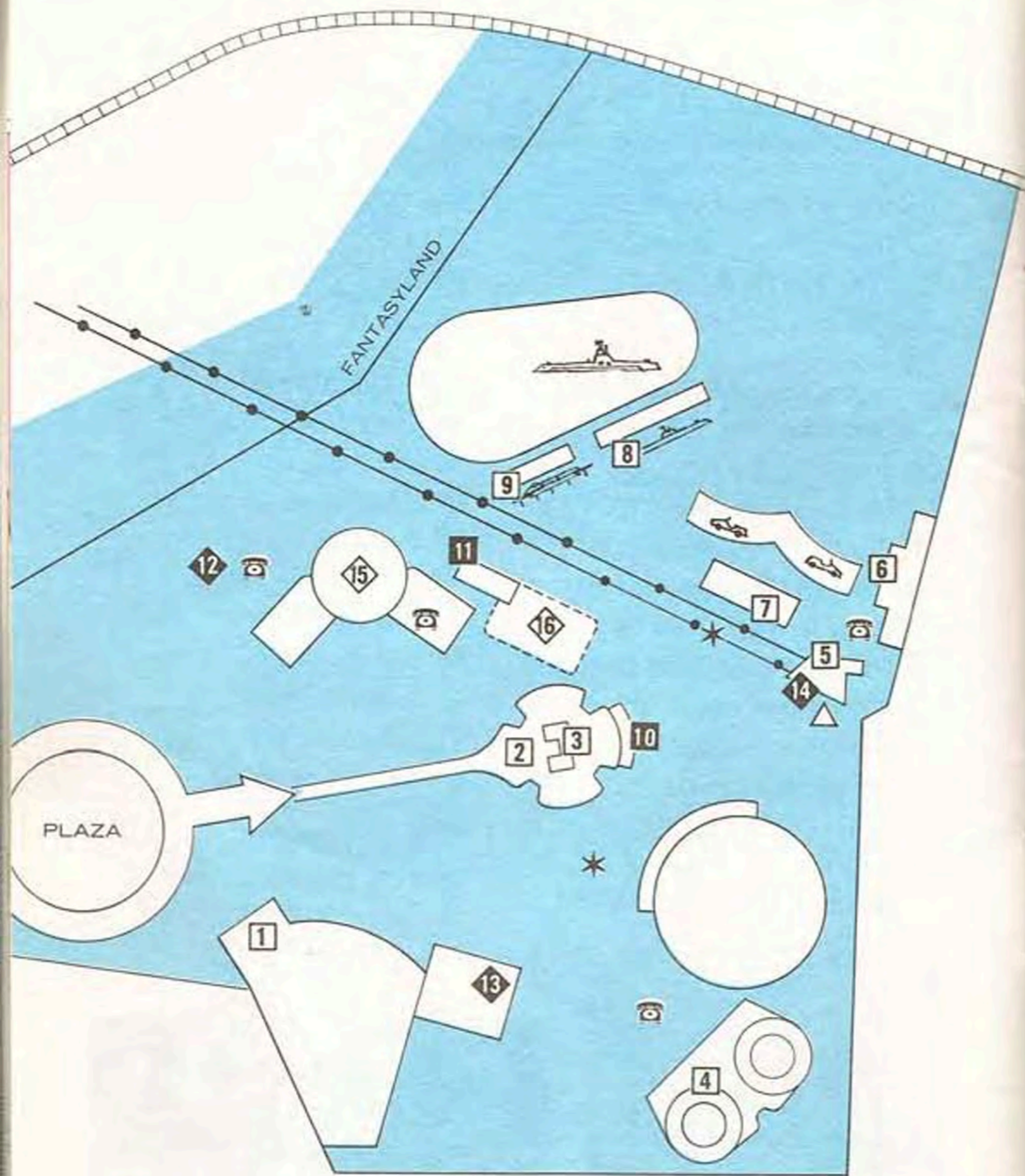

## ADVENTURES AND ATTRACTIONS

- 1 Adventure thru Inner Space presented by Monsanto
- 2 PeopleMover "D" presented by Goodyear
- 3 Rocket Jets "D"
- 4 Flight to the Moon "D" presented by McDonnell Douglas
- 5 Skyway to Fantasyland "D"
- 6 Santa Fe & Disneyland Railroad "D"
- 7 Tomorrowland Autopia "C"
- 8 Submarine Voyage "E"
- 9 Disneyland Alweg Monorail System "E"

- 11 Coca-Cola Tomorrowland Terrace

## SHOPS AND STORES

- 12 Souvenir Stand
- 13 The Character Shop
- 14 "Mod" Hatter Shop

## FREE SHOWS AND EXHIBITS

- 15 Circle-Vision 360 presented by Bell Telephone
- 16 Coca-Cola Tomorrowland Terrace

## FOOD AND REFRESHMENTS

- 10 The Space Bar

- ☎ TELEPHONES
- △ REST ROOMS
- \* TICKET BOOTHS

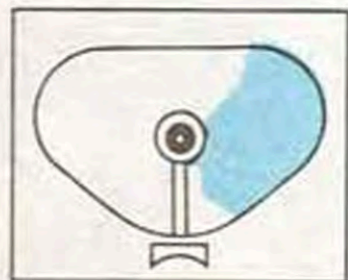
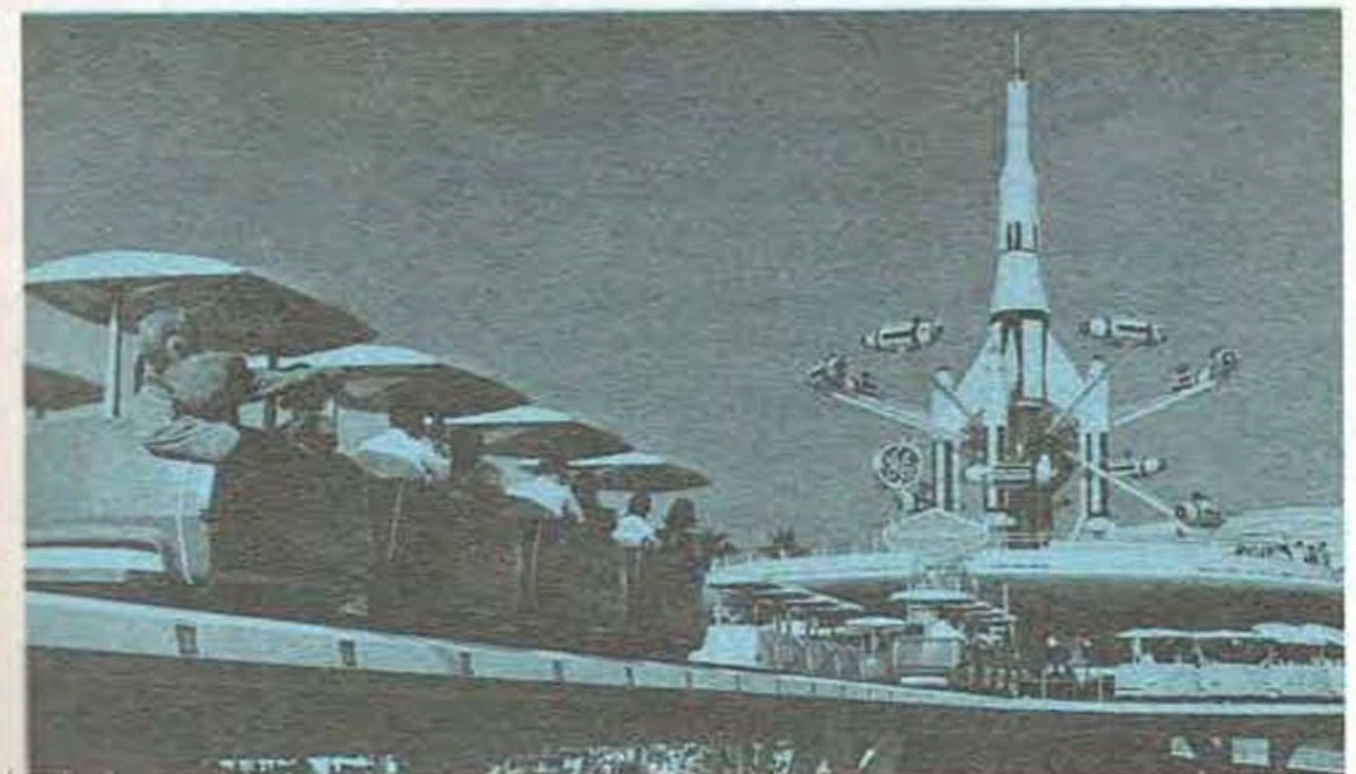

# Food and Refreshments

In Disneyland, you'll find a large variety of restaurants and refreshment centers, ranging from elegant waitress service to popcorn and ice cream wagons. You will discover a menu to please every palate and pocketbook.

## MAIN STREET, U.S.A.

**Carnation Ice Cream Parlor** — Waitress service. Breakfast served until 11 a.m. Hot and cold sandwiches, salads, beverages and ice cream specialities.

**Carnation Plaza Gardens** — Hamburgers, hot dogs, beverages, sundaes and ice cream cones.

**Coca-Cola Refreshment Corner** — Coca-Cola, hot dogs, brownies and chips.

**Hills Bros. Coffee House & Gardens** — Waitress service. Breakfast served until 11 a.m. Hot and cold sandwiches, soup, salads, desserts and beverages.

**Plaza Inn** — Buffet service a la carte. Luncheon and dinner. Baked chicken, pot roast, veal, fish, spaghetti, salads, hot sandwiches, desserts and beverages. Children's portions.

**Plaza Pavilion** — Buffet service. Luncheon and dinner. Fried chicken, braised sirloin tips, spaghetti, hot sandwiches, salads, desserts and beverage. Children's portions. Open holiday periods only.

**Sunkist Citrus House** — Fresh orange juice, lemonade, lemon tarts, cheesecake and frozen juice bars.

## ADVENTURELAND

**Sunkist "I Presume"** — Fresh orange juice, lemonade, donuts, coffee and jungle juleps.

**Tahitian Terrace** — Waitress service. Luncheon and dinner. Authentic Polynesian specialties, Teriyaki steak and Monte Cristo sandwiches, desserts and beverages. Children's portions. Open Thanksgiving, Christmas, and Easter periods only.

**Tiki Juice Bar** — Serving Tahiti punch. Open holiday periods only.

## NEW ORLEANS SQUARE

**Blue Bayou Restaurant** — Waitress service, luncheon and dinner. Seafoods, chicken, beef entrees, Monte Cristo sandwiches, salads, desserts and beverages. Children's portions.

**The French Market** — Buffet a la carte, luncheon and dinner. Chicken, fried shrimp, spareribs, bell peppers, salads, hot sandwiches and desserts. Children's portions.

**Sara Lee Cafe Orleans** — Waitress service. Sandwiches, exotic coffee, and desserts from the Kitchens of Sara Lee.

**The Mint Julep Bar** — Choux fritters, ice cream bars, non-alcoholic mint juleps and lemonade. Open weekends and holiday periods only.

**Royal Street Veranda** — Fruit punch, frozen bananas and choux fritters. Open weekends and holiday periods only.

## BEAR COUNTRY

**Hungry Bear Restaurant** — Hamburgers, hot dogs, salads, sandwiches and beverages.

**Mile Long Bar** — Sandwiches, beverages, ice cream and frozen bananas.

## FRONTIERLAND

**Oscar Mayer River Belle Terrace** — Plain and fancy pancakes, waffles, ham, bacon, sausage, eggs, specialty sandwiches, and beverages.

**Casa de Fritos** — Mexican food specialties, combination plates and Fritos.

**Fort Wilderness Snack Bar** — Cider, lemonade, Pepsi-Cola, coffee and cookies.

**Oaks Tavern** — Hamburgers, hot dogs, chili, beverages and pastries.

**Pepsi-Cola's Golden Horseshoe** — Pepsi-Cola, cold sandwiches and chips.

**Wheelhouse** — Hamburgers, hot dogs, milk shakes, beverages and ice cream. Open some weekends and holiday periods only.

## FANTASYLAND

**Character Food Facilities** — Hamburgers, hot dogs and beverages.

**Captain Hook's Pirate Ship** — Hot and cold seafood sandwiches, salads, and beverages. Open weekends and holiday periods only.

**Welch's Grape Juice Bar** — Pure grape juice, frozen juice bars and chips.

## TOMORROWLAND

**Coca-Cola Tomorrowland Terrace** — Hamburgers, hot dogs, salads, sandwiches, desserts and beverages.

**The Space Bar** — Cherry mist punch, popcorn, ice cream, and frozen bananas.

# Shops and Stores

## MAIN STREET, U.S.A.

**Art Festival** — Have your own pastel profile drawn in a few minutes.

**Camera Shop** — Film and other photographic equipment. Processing available on slides, movies, and prints. Located in GAF Photo Salon.

**Candle Shop** — A selection of candles from all over the world.

**Candy Palace** — For the most discriminating sweet tooth.

**China Shop** — Decorative accessories and gifts in ceramic and glass.

**Crystal Arts** — Fine hand cut glass artware, special engraving, and monogramming.

**Emporium** — Featuring a complete selection of gifts for the entire family.

**Flower Market** — Unusual man-made flowers and floral pieces.

**Glassblower** — Gift items in glass created before your eyes.

**Hallmark Communication Center** — A complete display of Hallmark greeting cards, party packs and other paper items.

**Hurricane Lamp Shop** — Complete hurricane lamp selection.



**Mad Hatter Shop** — Colorful variety of unique Disneyland hats.

**Magic Shop** — Unusual selection of tricks, masks, gadgets and souvenirs.

**Market House** — An old-fashioned general store complete with cider and dill pickles.

**New Century Clock Shop** — Timepieces by Elgin Time Products. Featuring a complete selection of Mickey Mouse and Disney character watches and clocks.

**"Rings 'n Things"** — Large selection of men's and women's jewelry.

**Silhouette Studio** — Artists create and frame silhouettes while you wait.

**Souvenir Stands** — Complete selection of Disneyland souvenirs.

**Story Book Shop** — A wide selection of Walt Disney books.

**Tobacco Shop** — Tobaccos and smoking accessories from around the world.

## ADVENTURELAND

**Adventureland Bazaar Area** — Rare products and gifts from all over the world in a jungle atmosphere. Includes ADVENTURELAND TRADERS, FAR EAST IMPORTS and MAGIC CARPET BAZAAR.

**Guatemalan Weavers** — Featuring imported Guatemalan clothing and jewelry.

**Tropical Imports** — South Sea Island hats, bags and shells.

## NEW ORLEANS SQUARE

**Mlle. Antoinette's Parfumerie** — A complete line of select perfumes and the services of a perfumer to blend unique fragrances.

**Cristal d'Orleans** — A room of glass, highlighted by glass cutting and engraving.

**Le Forgeron** — A selection of leaded glass, wrought iron, and metal accessories for the home.

**Le Gourmet** — Unusual cooking and serving accessories available, along with a selection of exotic spices.

**Laffite's Silver Shop** — Wide selection of silver gifts, combined with engraving facility for personalizing.

**Marché Aux Fleurs, Sacs Et Modes** — Hats, plain and hand decorated; film and cigarettes.

## NEW ORLEANS SQUARE (Continued)

**One-Of-A-Kind-Shop** — Exacting guests will find choice antiques, reproductions, and other unique gifts gathered from all parts of the world.

**Portrait Artist** — Artist does portrait in water colors.

## BEAR COUNTRY

**Indian Trading Post** — a re-creation of an Indian store, featuring realistic Indian gifts.

**Wilderness Outpost** — gifts and apparel with a "Bear Country" flavor.

## FRONTIERLAND

**Camera Shop** — Complete line of GAF film and processing mailers, cameras, and camera accessories.

**Davy Crockett Arcade** — Includes Frontierland Hats; the Frontier Print Shop, with custom head-lined newspapers and stationery; Frontier Rock Shop; the Mexican Shop; and a Souvenir Stand.

**Frontier Trading Post** — Western items, apparel and gifts. Film.  
**Pendleton Woolen Mills Store** — A complete selection of Pendleton woolen fabrics and clothing.



## FANTASYLAND

**Arts and Crafts** — Features unusual clocks, Hummel ceramics, and other decorative handcrafts.

**Caricatures** — Have your caricature made in minutes.

**Castle Candy Shoppe** — A variety of unusual candies.

**Fantasy Gift Fair** — Assorted gifts, toys for the young at heart.

**Glassblower** — Enjoy watching the glassblower at work.

**Mad Hatter** — Hats of every size, shape and color.

**Merlin's Magic Shop** — A medieval setting for a large selection of magic supplies and tricks, plus expert demonstrations.

**Small World Stand** — Unique gifts from many lands.

**Souvenir Stands** — Three outdoor stores with a selection of Disneyland souvenirs.

**Tinkerbell Toy Store** — Toys for children of all ages, also a complete doll shop.

## TOMORROWLAND

**"Mod" Hatter Shop** — Colorful variety of unique Disneyland hats.

**Souvenir Stand** — Complete selection of Disneyland souvenirs.

**The Character Shop** — A wide selection of Disneyland souvenirs and other Disney merchandise.



# Your Disneyland Entertainment Calender

Effective 9-9-73 to 2-24-74  
(Subject to change without notice)

## DAILY ENTERTAINMENT

**Blue Bayou Pianist** — Melodies to complement your dining experience at the Blue Bayou Restaurant in New Orleans Square.

**Coca-Cola Tomorrowland Terrace Entertainers** — The upbeat sounds of today performed on the Tomorrowland Terrace in Tomorrowland.

**Disneyland Band** — This popular 20-piece band performs for your enjoyment daily throughout Disneyland in parades and concerts.

**Mickey Mouse and Friends** — The Disney characters meet and greet you in Town Square, on Main Street, U.S.A., in New Orleans Square, Fantasyland, and in Adventureland.

**Pepsi-Cola's Golden Horseshoe Review** — A wild, way-out West vaudeville show with singing, dancing, and comedy entertainment. Located in Frontierland. Five shows daily.

**Plaza Inn Accordionist** — Music to accompany your dining in the elegant Plaza Inn on Main Street, U.S.A.

**Royal Street Bachelors** — This trio of musicians performs on the quiet streets and courtyards of New Orleans Square.

## WEEKENDS AND HOLIDAYS

**Banjo Kings** — Happy music to accompany your trip down the Rivers of America aboard the Mark Twain Riverboat.

**Dapper Dans** — This popular barbershop quartet performs on Main Street, U.S.A.

**Disneyland Characters on Parade** — Weekends and holidays, Mickey Mouse and all of his friends parade and perform down Main Street, U.S.A. through Fantasyland, to "It's A Small World."



**Hans, Otto, and Gretchen** — Three courageous mountain climbers scale the treacherous slopes of Disneyland's Mighty Mat-terhorn.

**Pearly Band** — Music "Mary Poppins" style performed by these strolling musicians.

## SPECIAL EVENTS AND ENTERTAINMENT

**50th ANNIVERSARY CELEBRATION** — October 20 and 21. A weekend celebrating the 50th Anniversary of Walt Disney Productions. Highlights include special Disney Character Parades, free gifts to all children 11 years of age and under, plus special stage shows and entertainment.

**Thanksgiving Holidays** — November 22, 23, 24, & 25 — Special daytime entertainment is only part of the fun during Disneyland's Thanksgiving Holiday Celebration. Nighttime (November 23 and 24 only) has its own special magic, too, as name entertainers, name big bands, and rock groups appear on Disneyland stages for your listening and dancing pleasure.

**Christmas Holidays** — December 15 - January 1 — Fantasy on Parade — The highlight of Disneyland's fall/winter season is this spectacular parade, which features a host of famous Disney characters in a gala cavalcade of colors and sounds. The parade is daily. The premiere parade on December 15, is held at 9 p.m.



**New Year's Eve Party** — December 31 — From 8:30 p.m. to 2:30 a.m., Disneyland guests can ring out the old year and bring in the new during this exciting New Year's Eve Party, which features a full evening of listening and dancing to top name entertainers and a spectacular fireworks display at midnight. (Special tickets for this event, which also include unlimited use of all Disneyland attractions except shooting galleries, must be purchased in advance.)

**Small World Days** — January 12 & 13 — Disneyland takes on an international flavor during this weekend salute to the music, dances, and customs of many different nations. Special entertainment is planned for all Disneyland stages.

**Valentine's Party** — February 9 — From 8:30 p.m. to 1:30 a.m., the beat goes on, and on, and on as Disneyland features top name recording groups for an evening of listening and dancing fun. (Special tickets for this event, which also include unlimited use of all Disneyland attractions except shooting galleries, must be purchased in advance.)

**Star-Spangled Holidays** — February 15, 16, & 17 — A salute to America's heritage is the theme of this three-day holiday weekend. Featured are guest entertainers and performances by a 500-voice massed choir and a 200-piece massed band. During the day, the "I Am An American" ceremony is performed each afternoon in Town Square.

## Free Shows and Exhibits

You will enjoy visiting these outstanding free shows and exhibits sponsored by many nationally famous companies for your enjoyment.

### MAIN STREET, U.S.A.

**The Walt Disney Story presented by Gulf** — Follow Walt Disney from his boyhood to the creation of Walt Disney World . . . see rare film footage narrated by Walt himself.

**GAF Photo Salon** — Camera exhibit and multi-screen film show. Free photo information and assistance.

### FRONTIERLAND

**Frontierland Arcade Gun Collection** — On display, over 50 rifles, pistols, and swords used in the early history of our country.

**Pepsi-Cola's Golden Horseshoe Revue** — An Old West vaudeville show featuring singing, dancing, and plenty of laughs.

### TOMORROWLAND

**Circle-Vision 360 presented by the Bell System** — A motion picture tour of America in an enlarged 360-degree theater. Also features the futuristic Picturephone, where you can see the person you are calling.

Walt Disney Productions  HAPPY YEARS OF FAMILY ENTERTAINMENT

